

# buades®

since 1900

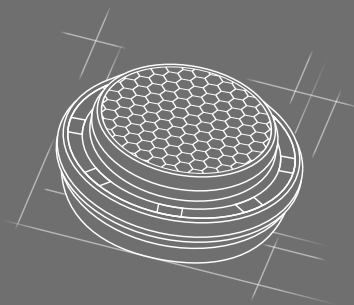

buades



## ahorro para el planeta y el bolsillo

*savings for the planet and the pocket*

nuestros aireadores SAVE WATER reducen el consumo de agua con una tecnología que permite no notar ningún cambio en el volumen del caudal

la innovadora tecnología de los reductores de caudal en las griferías buades® permiten, sin la necesidad de instalar ningún regulador de caudal externo, una **reducción del 50% en el consumo de agua**

además, reduciendo el volumen de agua consumida, se reduce el volumen de agua caliente y, por tanto, el consumo de energía

our SAVE WATER aerators reduce the flow rate to 5 liters per minute with a technology that does not notice any change in volume flow. The innovative technology of buades® flow reducers allows a 50% reduction in water consumption without the installation of any external flow regulator. In addition, by reducing the volume of water consumed, you will reduce the volume of hot water and therefore energy consumption



## menor consumo energético

*lower energy consumption*

con este sistema se proporciona **agua fría en la posición central**

debiendo girar la maneta hacia el lado izquierdo para obtener agua caliente se logra un menor consumo energético, evitando así que arranque la producción de agua caliente con una **total comodidad para el usuario**

with this system, cold water is provided in the central position. By turning the handle to the left to obtain hot water, a lower energy consumption is achieved, thus preventing the hot water production from starting, ensuring total comfort for the user

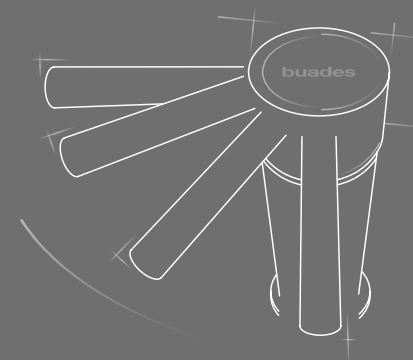

## innovación e ingeniería de precisión

*innovation and engineering precision*

en buades® trabajamos continuamente en la mejora de los mecanismos y el desarrollo de los productos que ofrezcan la **mejor experiencia** al usuario y los **precios más competitivos**

nuestra labor de investigación se centra en la implementación de las ingenierías que permiten **mejores regulaciones de caudal, temperatura y lubricación** de los discos cerámicos

in buades®, we continuously work on improving mechanisms and developing products that offer the best user experience and the most competitive prices. Our research efforts focus on implementing engineering solutions that enable better regulation of flow, temperature, and lubrication for ceramic discs

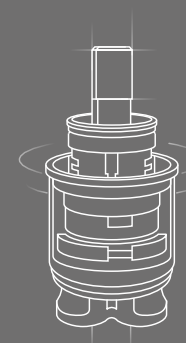

## perfección y facilidad en empotrados

*easy and perfect installation of concealed faucets*

los sistemas B BOX buades® son cajas empotradas de 1 pieza disponibles para 1, 2 o 3 vías que confieren una **garantía de seguridad y durabilidad** de primer nivel

además, es un sistema con una **gran facilidad de montaje y desmontaje**

the B BOX buades® systems are 1-piece built-in boxes available for 1, 2 or 3 ways that provide a guarantee of first-class security and durability, with great ease of assembly and disassembly

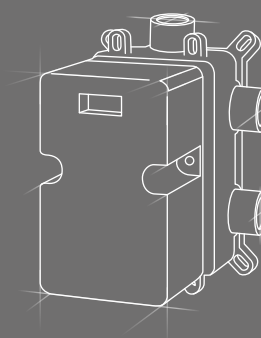





un grifo para cada **estilo**

*a faucet for every kitchen style*

ART COLLECTION

FLEX

CLASSIC

EXTRAÍBLES

AQUA PURE

ESSENTIAL

# cocinas





# cocinas | ART COLLECTION



las griferías  
más **chic**

*the most stylish  
kitchen faucets*







buades®

**VITAL-NOX**

**mezclador monomando caño alto  
acero inoxidable**

*single lever stainless steel high spout sink mixer*

- cartucho cerámico 35 mm  
*35 mm ceramic cartridge*
- caño giratorio  
*swivel spout*
- aireador anticalcáreo  
*antiscala aerator*
- conexiones flexibles 3/8" 360 mm certificadas  
*certified flexible 3/8" inlet pipes 360 mm*
- acero inoxidable AISI 304  
*AISI 304 stainless steel*



**Sweet move®**  
*Sweet move®*



**Aireador antical**  
*Anti-scale aerator*



**Sistema Easy Fit®**  
*Easy Fit® system*



**Sin plomo**  
*Lead free*



**Fácil montaje**  
*Easy Fit*



**Acero inoxidable**  
*Stainless steel*



**Ecológico**  
*Ecological*



**Ahorra un 70% de agua**  
*Save 70% of water*



- BD.5195451.IX
- BD.5195451.RC
- BD.5195451.OC

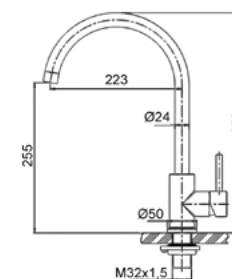

**.IX**  
inox  
inox

**.RC PVD**  
oro rosa cepillado  
brushed rose gold

**.OC PVD**  
oro cepillado  
brushed gold



**el caño perfecto  
compatible con  
la maneta a elegir**

*the perfect spout compatible  
with the handle of your choice*

**buades®**

**monomando caño alto**  
*single lever high spout  
sink mixer*

- cartucho cerámico 35 mm  
*35 mm ceramic cartridge*
- caño giratorio  
*swivel spout*
- conexiones flexibles 3/8"  
*360 mm certificadas  
certified flexible 3/8"  
inlet pipes 360 mm*

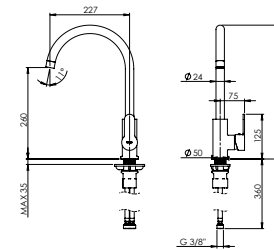

**AKARA**

- BD.519547F.CH
- BD.519547F.BK
- BD.519547F.WH
- BD.519547F.CT
- BD.519547F.DC
- BD.519547F.DK
- BD.519547F.LN
- BD.519547F.MN
- BD.519547F.SG



**TORUK**

- BD.519548F.CH
- BD.519548F.BK
- BD.519548F.WH
- BD.519548F.CT
- BD.519548F.DC
- BD.519548F.DK
- BD.519548F.LN
- BD.519548F.MN
- BD.519548F.SG



**SCOTT**

- BD.519545F.CH
- BD.519545F.BK
- BD.519545F.WH
- BD.519545F.CT
- BD.519545F.DC
- BD.519545F.DK
- BD.519545F.LN
- BD.519545F.MN
- BD.519545F.SG



**VITAL**

- BD.519546F.CH
- BD.519546F.BK
- BD.519546F.WH
- BD.519546F.CT
- BD.519546F.DC
- BD.519546F.DK
- BD.519546F.LN
- BD.519546F.MN
- BD.519546F.SG

**.CH**  
cromo  
chrome



**.BK**  
negro  
black



**.WH**  
blanco  
white



**.CT**  
cortén  
corten



**.DC**  
desert camel  
desert camel



**.DK**  
dakota  
dakota



**.LN**  
luna  
moon



**.MN**  
mar del norte  
north sea



**.SG**  
gris saturno  
saturn grey



**Sweet move®**  
*Sweet move®*



**Aireador antical**  
*Anti-scale aerator*



**Sistema Easy Fit®**  
*Easy Fit® system*



**Apertura en frío**  
*Cold opening*



**Ecológico**  
*Ecological*



**Ahorra un 70% de agua**  
*Save 70% of water*







**buades**<sup>®</sup>

**.WH**  
blanco  
white



**.LN**  
luna  
moon



**.DK**  
dakota  
dakota



**.SG**  
gris saturno  
saturn grey



**.DC**  
desert camel  
desert camel



**.CT**  
cortén  
corten



**.CH**  
cromo  
chrome



**.MN**  
mar del norte  
north sea



**.BK**  
negro  
black







**RAYVEN**

**mezclador monomando caño alto  
acero inoxidable**  
*single lever stainless steel high spout sink mixer*

- cartucho cerámico 35 mm  
*35 mm ceramic cartridge*
- caño giratorio  
*swivel spout*
- aireador anticalcáreo  
*antiscala aerator*
- conexiones flexibles 3/8" 360 mm certificadas  
*certified flexible 3/8" inlet pipes 360 mm*
- acero inoxidable AISI 304  
*AISI 304 stainless steel*



**Sweet move®**  
*Sweet move®*



**Aireador anticalcáreo**  
*Anti-scale aerator*



**Sistema Easy Fit®**  
*Easy Fit® system*



**Sin plomo**  
*Lead free*



**Fácil montaje**  
*Easy Fit*



**Acero inoxidable**  
*Stainless steel*



**Ecológico**  
*Ecological*



**Ahorra un 70% de agua**  
*Save 70% of water*



- BD.5195471.IX
- BD.5195471.BK
- BD.5195471.RC
- BD.5195471.OC

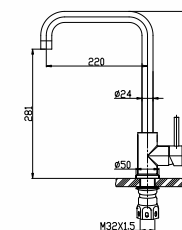

**.IX**  
inox  
inox



**.BK**  
negro  
black



**.RC PVD**  
oro rosa cepillado  
brushed rose gold



**.OC PVD**  
oro cepillado  
brushed gold







## KUATRO

**mezclador monomando caño alto  
acero inoxidable**
*single lever stainless steel high spout sink mixer*

- cartucho cerámico 35 mm  
*35 mm ceramic cartridge*
- caño giratorio  
*swivel spout*
- aireador anticalcáreo  
*antiscalc aerator*
- conexiones flexibles 3/8" 360 mm certificadas  
*certified flexible 3/8" inlet pipes 360 mm*
- acero inoxidable AISI 304  
*AISI 304 stainless steel*

**Sweet move®**  
*Sweet move®*

**Sin plomo**  
*Lead free*

**Ecológico**  
*Ecological*

**Aireador antical**  
*Anti-scale aerator*

**Fácil montaje**  
*Easy Fit*

**Ahorra un 70% de agua**  
*Save 70% of water*

**Sistema Easy Fit®**  
*Easy Fit® system*

**Acero inoxidable**  
*Stainless steel*

■ BD.5195461.IX

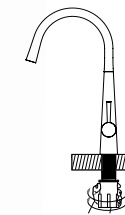
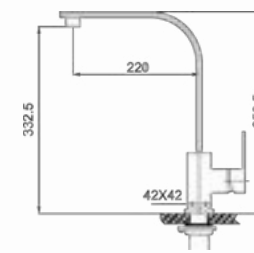
**buades® | easy fit**

con el sistema de fijación buades® Easy Fit® podemos instalar fácilmente nuestro grifo de fregadero en dos minutos y sin la necesidad de utilizar herramientas

*with buades® Easy Fit system we can easily install our sink mixer in two minutes without using any tool to fix it*



## QUAD AIR

mezclador monomando  
fregadero*single lever kitchen sink mixer*

- cartucho cerámico 35 mm  
*35 mm ceramic cartridge*
- caño giratorio  
*swivel spout*
- conexiones flexibles 3/8"  
*360 mm certificadas*  
*certified flexible 3/8"*  
*inlet pipes 360 mm*

Sweet move®  
*Sweet move®*Aireador antical  
*Anti-scale aerator*Ecológico  
*Ecological*Ahorra un 70% de agua  
*Save 70% of water*

■ BD.5195271.CH

■ BD.5195271.BK

■ BD.5195271.WH

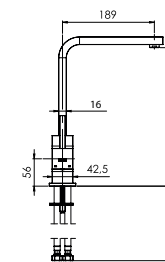
.CH  
cromo  
*chrome*.BK  
negro  
*black*.WH  
blanco  
*white*





## MO'AT

**monomando fregadero caño alto**  
single lever high spout  
kitchen sink mixer

- cartucho cerámico 25 mm  
25 mm ceramic cartridge
- caño giratorio  
swivel spout
- aireador anticalcáreo  
anti-scale aerator
- conexiones flexibles 3/8" 360 mm certificadas  
certified flexible 3/8" inlet pipes 360 mm



Sweet move®  
Sweet move®



Aireador antical  
Anti-scale aerator



Ecológico  
Ecological



Ahorra un 70% de agua  
Save 70% of water

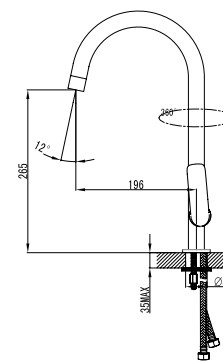

■ BD.5195212.CH  
■ BD.5195212.BK  
■ BD.5195212.WH

.CH  
cromo  
chrome

.BK  
negro  
black

.WH  
blanco  
white



budes®

## CLARK

**monomando fregadero caño alto**  
single lever high spout  
kitchen sink mixer

- cartucho cerámico 35 mm  
35 mm ceramic cartridge
- caño giratorio  
swivel spout
- aireador anticalcáreo  
anti-scale aerator
- conexiones flexibles 3/8" 360 mm certificadas  
certified flexible 3/8" inlet pipes 360 mm



**Sweet move®**  
Sweet move®



**Aireador anticalcáreo**  
Anti-scale aerator



**Sistema Easy Fit®**  
Easy Fit® system



**Ecológico**  
Ecological



**Ahorra un 70% de agua**  
Save 70% of water



■ BD.5195521.CH

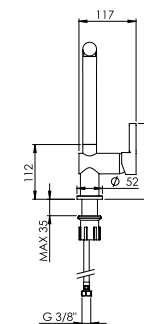
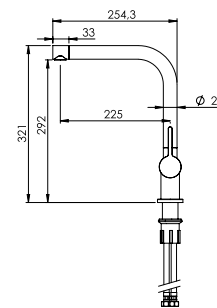

.CH  
cromo  
chrome





**NEW NORAY**

**monomando fregadero caño alto**  
*single lever high spout kitchen sink mixer*

- cartucho cerámico 26 mm  
*26 mm ceramic cartridge*
- caño fundido giratorio  
*casted swivel spout*
- aireador anticalcáreo  
*anti-scale aerator*
- conexiones flexibles 3/8" 360 mm certificadas  
*certified flexible 3/8" inlet pipes 360 mm*



**Sweet move<sup>®</sup>**  
*Sweet move<sup>®</sup>*



**Aireador antical**  
*Anti-scale aerator*



**Sistema Easy Fit<sup>®</sup>**  
*Easy Fit<sup>®</sup> system*



**Ecológico**  
*Ecological*



**Ahorra un 70% de agua**  
*Save 70% of water*



- BD.5195N61.CH
- BD.5195N61.BK
- BD.5195N61.WH

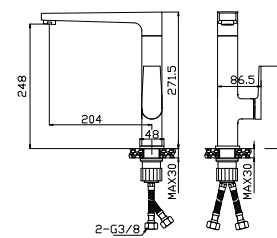

**.CH**  
cromo  
*chrome*



**.BK**  
negro  
*black*



**.WH**  
blanco  
*white*



**CÓRCEGA****mezclador monomando  
fregadero bajo ventana caño alto***single lever under window high spout kitchen sink mixer*

- cartucho de discos cerámicos 40 mm  
*40 mm ceramic cartridge*
- caño giratorio abatible  
*folding swivel spout*
- conexiones flexibles 3/8" 360 mm certificadas  
*certified flexible 3/8" inlet pipes 360 mm*

**Sweet move®**  
*Sweet move®***Aireador antical**  
*Anti-scale aerator***Abatible**  
*Folding***Ecológico**  
*Ecological***Ahorra un 70% de agua**  
*Save 70% of water*

BD.5195311.CH

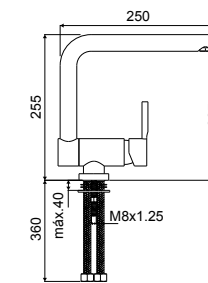
**.CH**  
cromo  
chrome**grifería abatible**

en buades® tenemos un grifo adaptado a cada necesidad el particular diseño de nuestro modelo CÓRCEGA le permitirá con un simple movimiento abatir el caño de su grifería para poder abrir y cerrar la ventana de su cocina de forma sencilla

*in buades® we have products adapted to all needs. The peculiar design of our model CÓRCEGA will allow you to move apart the spout of your tap with a simple gesture to allow you to open and close your window with total simplicity*



# cocinas EXTRAÍBLES

la grifería más profesional  
**en tu hogar**

*most professional  
faucets in home*





# cocinas | EXTRAÍBLES



## ELYSIUM

**monomando caño alto extraíble  
acero inoxidable**  
*single lever inox pull out high spout sink mixer*

- cartucho cerámico 25 mm  
*25 mm ceramic cartridge*
- caño giratorio  
*swivel spout*
- ducha extraíble 2 funciones  
con aireador anticalcáreo  
*2 function pull down shower  
with anti-scale aerator*
- conexiones flexibles 3/8"  
360 mm certificadas  
*certified flexible 3/8"  
inlet pipes 360 mm*



**Sweet move®**  
*Sweet move®*



**Aireador antical**  
*Anti-scale aerator*



**Extra resistente**  
*Extra resistant*



**Sin plomo**  
*Lead free*



**Extraíble**  
*Pull Down*



**Sistema Easy Fit®**  
*Easy Fit® system*



**Acero inoxidable**  
*Stainless steel*



**Ecológico**  
*Ecological*



**Ahorra un 70% de agua**  
*Save 70% of water*



- BD.5199011.CH
- BD.5199011.BS
- BD.5199011.OC

- .CH**  
cromo  
*chrome*
- .BS PVD**  
negro espacial  
*black space*
- .OC PVD**  
oro cepillado  
*brushed gold*





**KALE**

**monomando caño alto extraíble  
acero inoxidable**

*single lever inox pull out high spout sink mixer*

- cartucho cerámico 25 mm  
*25 mm ceramic cartridge*
- caño giratorio  
*swivel spout*
- ducha extraíble 2 funciones  
con aireador anticalcáreo  
*2 function pull down shower  
with anti-scale aerator*
- conexiones flexibles 3/8"  
360 mm certificadas  
*certified flexible 3/8"  
inlet pipes 360 mm*



**Sweet move®**  
*Sweet move®*



**Aireador anticalcáreo**  
*Anti-scale aerator*



**Extra resistente**  
*Extra resistant*



**Sin plomo**  
*Lead free*



**Extraíble**  
*Pull Down*



**Sistema Easy Fit®**  
*Easy Fit® system*



**INOX**  
*Acero inoxidable  
Stainless steel*



**Ecológico**  
*Ecological*



**Ahorra un 70% de agua**  
*Save 70% of water*

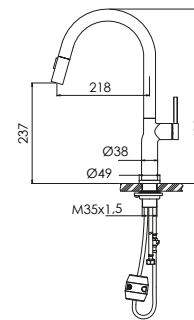

- BD.5195431.IX
- BD.5195431.BK
- BD.5195431.WH
- BD.5195431.RC
- BD.5195431.OC
- BD.5195431.BS

**.IX**  
inox  
*inox*

**.BK**  
negro  
*black*

**.WH**  
blanco  
*white*

**.OC PVD**  
oro cepillado  
*brushed gold*

**.RC PVD**  
oro rosa cepillado  
*brushed rose gold*

**.BS PVD**  
negro espacial  
*black space*



.IX  
inox  
inox

.BK  
negro  
black

.WH  
blanco  
white

.OC PVD  
oro cepillado  
brushed gold

.RC PVD  
oro rosa cepillado  
brushed rose gold

.BS PVD  
negro espacial  
black space





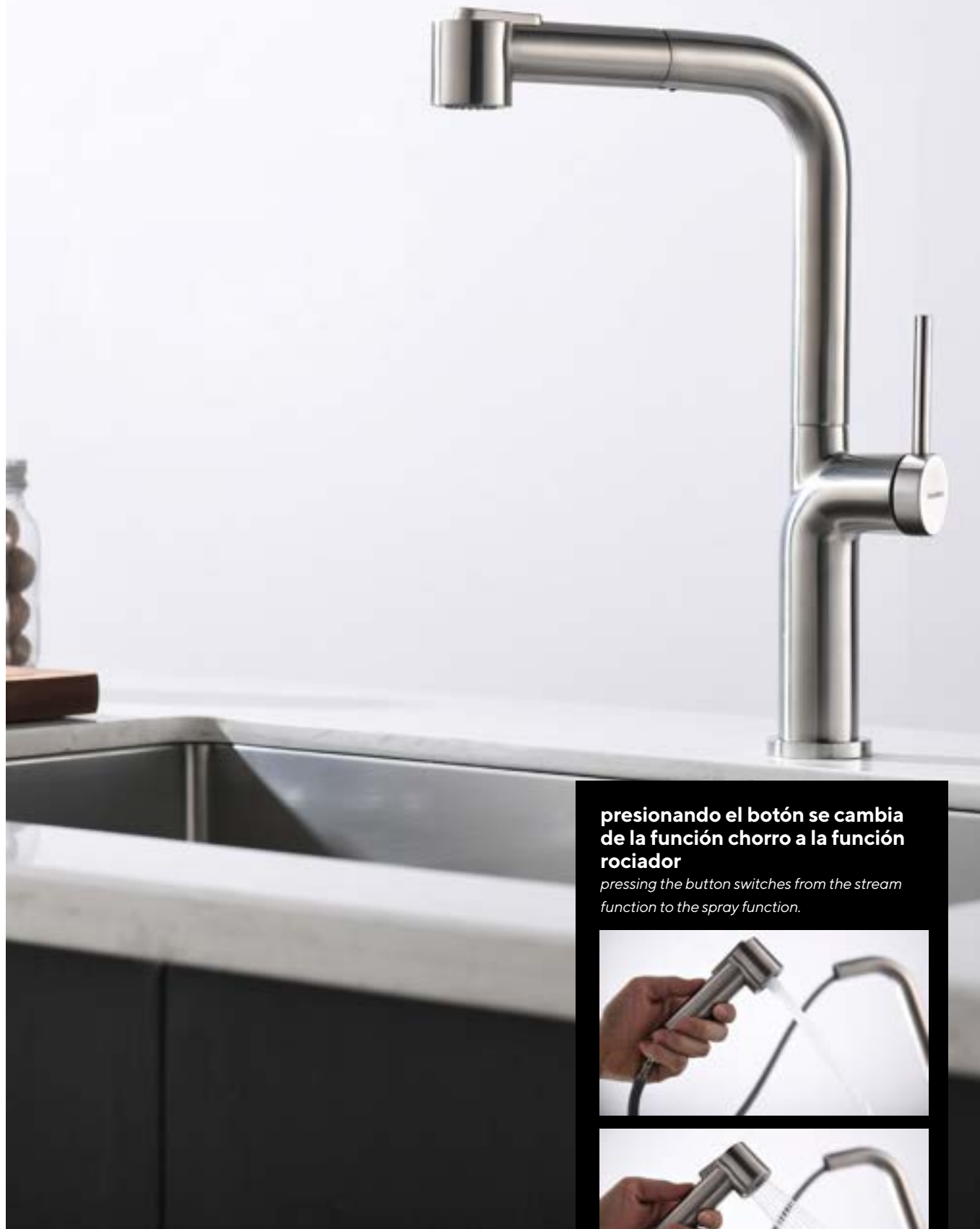

**presionando el botón se cambia de la función chorro a la función rociador**

*pressing the button switches from the stream function to the spray function.*



**KOTA**

**monomando caño alto extraíble  
acero inoxidable**

*single lever inox pull out high spout sink mixer*

- cartucho cerámico 25 mm  
*25 mm ceramic cartridge*
- caño giratorio  
*swivel spout*
- ducha extraíble 2 funciones con aireador anticalcáreo  
*2 function pull down shower with anti-scale aerator*
- conexiones flexibles 3/8" 360 mm certificadas  
*certified flexible 3/8" inlet pipes 360 mm*



**Sweet move®**  
*Sweet move®*



**Aireador antical**  
*Anti-scale aerator*



**Extra resistente**  
*Extra resistant*



**Sin plomo**  
*Lead free*



**Extraíble**  
*Pull Down*



**Sistema Easy Fit®**  
*Easy Fit® system*



**Acero inoxidable**  
*Stainless steel*



**Ecológico**  
*Ecological*



**Ahorra un 70% de agua**  
*Save 70% of water*



- BD.5195441.IX
- BD.5195441.BK
- BD.5195441.WH
- BD.5195441.RC
- BD.5195441.OC
- BD.5195441.BS

**.IX**  
inox  
inox

**.BK**  
negro  
black

**.WH**  
blanco  
white

**.OC PVD**  
oro cepillado  
brushed gold

**.RC PVD**  
oro rosa cepillado  
brushed rose gold

**.BS PVD**  
negro espacial  
black space





**.IX**  
inox  
inox

**.BK**  
negro  
black

**.WH**  
blanco  
white

**.OC PVD**  
oro cepillado  
brushed gold

**.RC PVD**  
oro rosa cepillado  
brushed rose gold

**.BS PVD**  
negro espacial  
black space







buades®

## E-NOX

### monomando caño alto acero inoxidable

*single lever stainless steel high spout sink mixer*

- cartucho cerámico 35 mm  
*35 mm ceramic cartridge*
- caño giratorio  
*swivel spout*
- conexiones flexibles 3/8" 360 mm certificadas  
*certified flexible 3/8" inlet pipes 360 mm*
- acero inoxidable AISI 304  
*AISI 304 stainless steel*
- ducha extraíble 2 funciones  
con aireador anticalcáreo  
*2 function pull down shower  
with anti-scale aerator*

■ BD.5195372.IX

■ BD.5195372.BK



### ducha extraíble 2 funciones

*cambie de modo presión a ducha con el  
movimiento de un botón*

*switch from pressure to shower mode with the  
movement of a button*



**Sweet move®**  
*Sweet move®*



**Aireador antical**  
*Anti-scale aerator*



**Sistema Easy Fit®**  
*Easy Fit® system*



**Sin plomo**  
*Lead free*



**Fácil montaje**  
*Easy Fit*



**Extra resistente**  
*Extra resistant*



**Extraíble**  
*Pull Down*



**INOX**  
*Acero inoxidable  
Stainless steel*



**Ecológico**  
*Ecological*



**Ahorra un 70% de agua**  
*Save 70% of water*



.IX  
inox  
inox

.BK  
negro  
black







buades®

## KON-IS

### monomando caño alto extraíble acero inoxidable

single lever inox pull out high spout sink mixer

- cartucho cerámico 35 mm apertura en frío  
cold opening 35 mm ceramic cartridge
- caño giratorio  
swivel spout
- ducha extraíble 2 funciones con aireador anticalcáreo  
2 function pull down shower with anti-scale aerator
- conexiones flexibles 3/8" 360 mm certificadas  
certified flexible 3/8" inlet pipes 360 mm



Sweet move®  
Sweet move®



Aireador antical  
Anti-scale aerator



Extra resistente  
Extra resistant



Sin plomo  
Lead free



Extraíble  
Pull Down



Sistema Easy Fit®  
Easy Fit® system



Acero inoxidable  
Stainless steel



Apertura en frío  
Cold opening



Ecológico  
Ecological



Ahorra un 70% de agua  
Save 70% of water



BD.5197011.CH

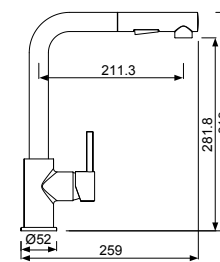

.CH  
cromo  
chrome

### SAE plug in + CQC by NEOPERL

el fácil sistema de conexión para nuestros flexos de ducha extraíbles de grifería de cocina le permitirá olvidarse de complicadas instalaciones

con este innovador sistema podrá instalar el flexo de ducha de su grifo de cocina sin herramientas y con un simple "click"

the easy connection system for our removable kitchen faucet shower hoses will allow you to forget about complicated installations. With this innovative system you can install the shower hose of your kitchen faucet without tools and with a simple click



buades®

ATIKA

**monomando caño alto extraíble  
acero inoxidable**

*single lever inox pull out high spout sink mixer*

- cartucho cerámico 35 mm apertura en frío  
*cold opening 35 mm ceramic cartridge*
- caño giratorio  
*swivel spout*
- ducha extraíble 2 funciones con aireador anticalcáreo  
*2 function pull down shower with anti-scale aerator*
- conexiones flexibles 3/8" 360 mm certificadas  
*certified flexible 3/8" inlet pipes 360 mm*



**Sweet move®**  
*Sweet move®*



**Aireador antical**  
*Anti-scale aerator*



**Extra resistente**  
*Extra resistant*



**Sin plomo**  
*Lead free*



**Extraíble**  
*Pull Down*



**Sistema Easy Fit®**  
*Easy Fit® system*



**Acero inoxidable**  
*Stainless steel*



**Apertura en frío**  
*Cold opening*



**Ecológico**  
*Ecological*



**Ahorra un 70% de agua**  
*Save 70% of water*



BD.5197021.IX

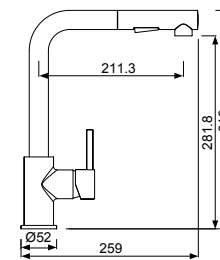

.IX  
inox  
inox



# cocinas FLEX



caños **flexibles**  
y **semirígidos**  
con acabados profesionales

*kitchen faucets with  
professional finishes  
and flexible and semi-rigid spouts*







## LEKSA

mezclador monomando  
fregadero*single lever kitchen sink mixer*

- cartucho cerámico 35 mm  
*35 mm ceramic cartridge*
- caño giratorio  
*swivel spout*
- conexiones flexibles 3/8"  
*360 mm certificadas  
certified flexible 3/8"  
inlet pipes 360 mm*
- sistema de apertura en frío  
*cold opening system*

Sweet move®  
*Sweet move®*Aireador antical  
*Anti-scale aerator*Apertura en frío  
*Cold opening*Acero inoxidable  
*Stainless steel*Flex semirigido  
*Semirigid flex*Sistema Easy Fit®  
*Easy Fit® system*Ecológico  
*Ecological*Ahorra un 70% de agua  
*Save 70% of water*

- BD.5195511.IX
- BD.5195511.BS

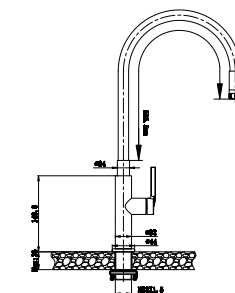
.IX  
inox  
*inox*.BS PVD  
negro espacial  
*black space*





## BIG-NOX

**monomando de acero inoxidable  
con caño alto flexible y extraíble**
*single lever stainless steel high spout sink mixer*

- cartucho cerámico 35 mm  
*35 mm ceramic cartridge*
- caño giratorio  
*swivel spout*
- aireador anticalcáreo  
*antiscala aerator*
- conexiones flexibles 3/8" 360 mm certificadas  
*certified flexible 3/8" inlet pipes 360 mm*
- acero inoxidable AISI 304  
*AISI 304 stainless steel*
- muelle flexible de silicona negra, caño giratorio con salida independiente y ducha con sistema autostop  
*big-nox model with flexible black silicone spring, rotating spout with independent outlet and shower with auto-stop system*

**Sweet move®**  
*Sweet move®*

**Aireador antical**  
*Anti-scale aerator*

**Sistema Easy Fit®**  
*Easy Fit® system*

**Sin plomo**  
*Lead free*

**Fácil montaje**  
*Easy Fit*

**Extra resistente**  
*Extra resistant*

**Extraíble**  
*Pull Down*

**Acero inoxidable**  
*Stainless steel*

**Ecológico**  
*Ecological*

**Ahorra un 70% de agua**  
*Save 70% of water*

BD.5195361.IX

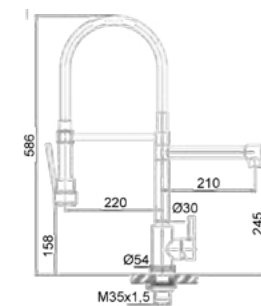



**MIKA**

**monomando de acero inoxidable con caño alto flexible y extraíble**

*single lever inox pull out high spout sink mixer*

- cartucho cerámico 25 mm  
*25 mm ceramic cartridge*
- caño giratorio  
*swivel spout*
- ducha extraíble 2 funciones con aireador anticalcáreo  
*2 function pull down shower with anti-scale aerator*
- conexiones flexibles 3/8" 360 mm certificadas  
*certified flexible 3/8" inlet pipes 360 mm*
- acabados .IX en acero inoxidable AISI 304 libres de plomo y sistema easy fit  
*.IX finishes in lead-free AISI 304 stainless steel and easy fit system*



**Sweet move®**  
*Sweet move®*



**Aireador antical**  
*Anti-scale aerator*



**Extra resistente**  
*Extra resistant*



**Sin plomo**  
*Lead free*



**Extraíble**  
*Pull Down*



**Sistema Easy Fit®**  
*Easy Fit® system*



**Acero inoxidable**  
*Stainless steel*



**Ecológico**  
*Ecological*



**Ahorra un 70% de agua**  
*Save 70% of water*

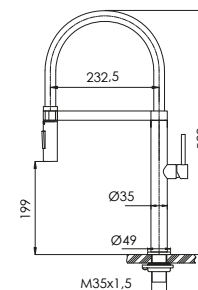

- BD.5195421.BK
- BD.5195421.IXWH
- BD.5195421.IXBK
- BD.5195421.RC
- BD.5195421.OC

**.IX**  
inox  
inox

**.BK**  
negro  
black

**.WH**  
blanco  
white

**.RC PVD**  
oro rosa cepillado  
brushed rose gold

**.OC PVD**  
oro cepillado  
brushed gold





**.IX**  
inox  
inox



**.BK**  
negro  
black



**.WH**  
blanco  
white



**.RC PVD**  
oro rosa cepillado  
brushed rose gold



**.OC PVD**  
oro cepillado  
brushed gold





## RHOLO

**monomando de acero inoxidable  
con caño alto flexible y extraíble**
*single lever inox pull out high spout sink mixer*

- cartucho cerámico 35 mm  
*35 mm ceramic cartridge*
- caño giratorio  
*swivel spout*
- ducha extraíble 2 funciones con aireador anticalcáreo  
*2 function pulldown shower with anti-scale aerator*
- conexiones flexibles 3/8" 360 mm certificadas  
*certified flexible 3/8" inlet pipes 360 mm*

**Sweet move®**  
*Sweet move®*

**Sin plomo**  
*Lead free*

**Ecológico**  
*Ecological*

**Aireador antical**  
*Anti-scale aerator*

**Extraíble**  
*Pull Down*

**Ahorra un 70% de agua**  
*Save 70% of water*

**Extra resistente**  
*Extra resistant*

**Sistema Easy Fit®**  
*Easy Fit® system*

BD.5195491.CH





**monomandos caño alto semiprofesional**

*single lever semi-professional high spout sink mixer*

- cartucho cerámico 35 mm  
*35 mm ceramic cartridge*
- caño giratorio  
*swivel spout*
- ducha extraíble 2 funciones con aireador anticalcáreo  
*2 function pull-down shower with anti-scale aerator*
- conexiones flexibles 3/8" 360 mm certificadas  
*certified flexible 3/8" inlet pipes 360 mm*
- modelo propesk-nox en inox sin plomo  
*propesk-nox model in lead-free stainless steel*



**Sweet move®**  
*Sweet move®*



**Sin plomo**  
*Lead free*



**INOX**  
*Acero inoxidable*  
*Stainless steel*



**Aireador anticalcáreo**  
*Anti-scale aerator*



**Extraíble**  
*Pull Down*



**Ecológico**  
*Ecological*



**INOX**  
*Acero inoxidable*  
*Stainless steel*



**Sistema Easy Fit®**  
*Easy Fit® system*



**Ahorra un 70% de agua**  
*Save 70% of water*



**PROPESK-1**

■ BD.5196071.CH

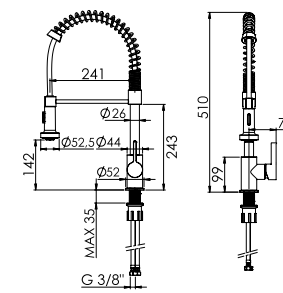

**PROPESK-2**

BD.5196081.CH

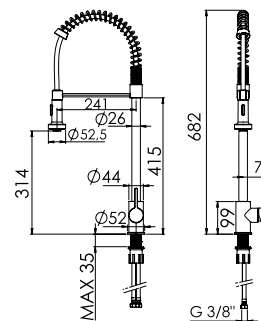

**PROPESK-NOX**

■ BD.5196091.IX

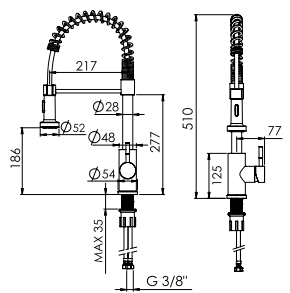

**.CH**  
cromo  
chrome

**.IX**  
inox  
inox

**cocinas**

AQUA PURE

**agua**

**premium  
en tu cocina**

*premium  
water in  
your kitchen*







## grifos de diseño innovador libres de plomo

*lead free innovatively designed faucets*

con nuestra gama de grifería específica para agua purificada BUADES OSMO ofrecemos la posibilidad de disponer de agua filtrada y agua corriente de red en un único grifo con dos salidas independientes en el mismo caño

una solución efectiva a la vez que elegante para no tener que utilizar grifos adicionales para nuestro sistema de purificación de agua

con mando o pulsador independientes para activar la función del agua purificada en el grifo

*with our BUADES OSMO range of taps specifically for purified water, we offer the possibility of having filtered water and mains water in a single tap with two independent outlets on the same pipe*

*a really effective solution as well as an elegant way to avoid additional taps in your sink for your water purifying system*

*with independent control or button to activate the purified water function in the tap*

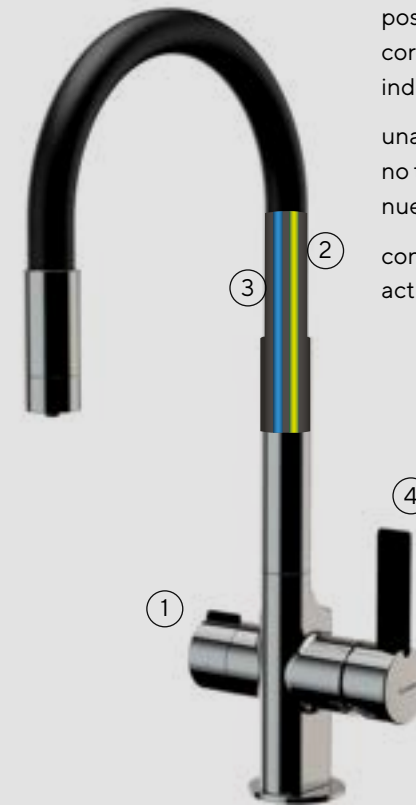

**1 mando agua filtrada**  
*filtered water switch*

**2 tubo agua filtrada**  
*filtered water pipeline*

**3 tubo agua corriente**  
*ordinary water pipeline*

**4 maneta activación agua de red**  
*mains water activation handle*

## sistema de filtración de carbón premium

*premium carbon filtration system*

el sistema de filtración de carbón bacteriostático reduce eficazmente el crecimiento de bacterias en el medio filtrante

la exclusiva prefiltración de carbón fibra proporciona una reducción mayor de olores, sabores, cloro y sus combinados, pesticidas y distintos compuestos orgánicos. Reduce las fibras de amianto y los quistes como el Cryptosporidium y la Giardia. Con una filtración nominal de partículas de hasta 0,5 micras de tamaño y un índice IODINE 1300, ofrece el mejor rendimiento y la mayor capacidad de filtración dándole al agua un sabor agradable y puro

innovador sistema de cambio de cartucho respetuoso con el medio ambiente para reducir la huella de CO<sub>2</sub>

reutilice el contenedor y cambie solo el cartucho interior del filtro

*the bacteriostatic carbon filtration system to effectively reduce bacterial growth in the filter media*

*the exclusive fibre-carbon pre-coat provides further reduction of odours, tastes, chlorine and its combinations, pesticides, and various organic compounds. Reduces asbestos fibres and cysts such as Cryptosporidium and Giardia. With a nominal filtration of particles as small as 0,5 microns and an IODINE index of 1300, it offers the best performance and the highest filtration capacity giving the water a pleasant and pure taste.*

*innovative eco-friendly cartridge change system to reduce CO<sub>2</sub> footprint*

*reuse the container and change only the inner filter cartridge*



# cocinas | AQUA PURE

## monomando fregadero purificador caño alto

single lever high spout sink mixer with purifying function

- cartucho cerámico 35 mm  
35 mm ceramic cartridge
- caño giratorio  
swivel spout
- conexiones flexibles 3/8" 360 mm certificadas  
certified flexible 3/8" inlet pipes 360 mm
- función purificadora de agua  
water purifying function
- montura cerámica para función purificadora  
ceramic headpart for purifying function



BD.510S021.CH

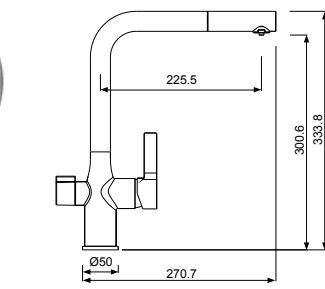

### pack AQUA PURE ONE

conjunto monomando cromado y sistema AQUA PURE  
chrome single lever set and AQUA PURE system

BD.PAPURE01.CH

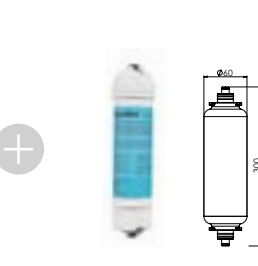

### pack SACRI FONTI ONE

conjunto monomando cromado y filtro CARBON  
chrome single lever set and CARBON filter

BD.SACF0N01.CH

## monomando fregadero purificador caño alto

single lever high spout sink mixer with purifying function

- cartucho cerámico 35 mm  
35 mm ceramic cartridge
- caño giratorio  
swivel spout
- conexiones flexibles 3/8" 360 mm certificadas  
certified flexible 3/8" inlet pipes 360 mm
- función purificadora de agua  
water purifying function
- montura cerámica para función purificadora  
ceramic headpart for purifying function

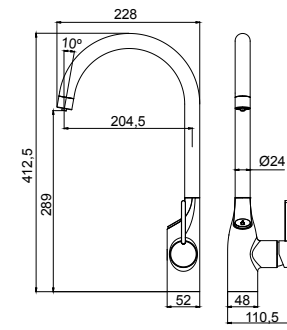

### pack AQUA PURE FIVE

conjunto monomando cromado y sistema AQUA PURE  
chrome single lever set and AQUA PURE system

BD.PAPURE02.CH



### pack SACRI FONTI FIVE

conjunto monomando cromado y filtro CARBON  
chrome single lever set and CARBON filter

BD.SACF0N02.CH

### OSMO ONE



Aireador antical  
Anti-scale aerator



Sweet move®  
Sweet move®



Purificador  
Purifier



Montura cerámica  
Ceramic head



Sistema Easy Fit®  
Easy Fit® system

### OSMO FIVE



Aireador antical  
Anti-scale aerator



Sweet move®  
Sweet move®



Purificador  
Purifier



Montura cerámica  
Ceramic head



Sistema Easy Fit®  
Easy Fit® system



BD.510S061.CH





# cocinas | AQUA PURE

## monomando fregadero purificador caño alto

single lever high spout sink mixer with purifying function

- cartucho cerámico 35 mm  
35 mm ceramic cartridge
- caño giratorio  
swivel spout
- conexiones flexibles 3/8" 360 mm certificadas  
certified flexible 3/8" inlet pipes 360 mm
- función purificadora de agua  
water purifying function
- montura cerámica para función purificadora  
ceramic headpart for purifying function

### OSMO SIX



Aireador antical  
Anti-scale aerator



Sweet move®  
Sweet move®



Purificador  
Purifier



Montura cerámica  
Ceramic head



Sistema Easy Fit®  
Easy Fit® system



BD.510S071.CH

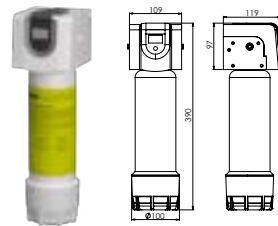
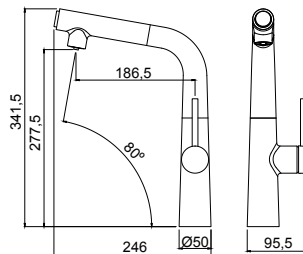

### pack AQUA PURE SIX

conjunto monomando cromado y sistema AQUA PURE  
chrome single lever set and AQUA PURE system

BD.PAPURE03.CH



### pack SACRI FONTEI SIX

conjunto monomando cromado y filtro CARBON  
chrome single lever set and CARBON filter

BD.SACF0N03.CH

.CH  
cromo  
chrome

buades®





# cocinas | AQUA PURE

## monomando fregadero purificador caño alto

single lever high spout sink mixer with purifying function

- cartucho cerámico 35 mm  
35 mm ceramic cartridge
- caño giratorio  
swivel spout
- conexiones flexibles 3/8" 360 mm certificadas  
certified flexible 3/8" inlet pipes 360 mm
- función purificadora de agua  
water purifying function
- montura cerámica para función purificadora  
ceramic headpart for purifying function



BD.510S081.CH

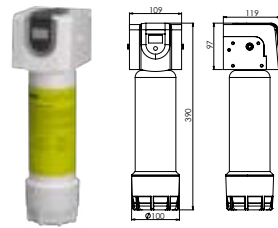

### pack AQUA PURE SEVEN

conjunto monomando cromado y sistema AQUA PURE  
chrome single lever set and AQUA PURE system

BD.PAPURE04.CH

## OSMO SEVEN



Aireador antical  
Anti-scale aerator



Sweet move®  
Sweet move®



Flex semirígido  
Semirigid flex



Purificador  
Purifier



Montura cerámica  
Ceramic head



Sistema Easy Fit®  
Easy Fit® system

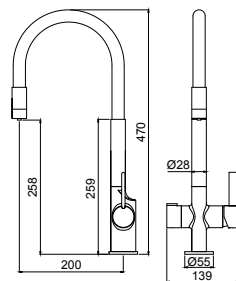

### pack SACRI FONTE SEVEN

conjunto monomando cromado y filtro CARBON  
chrome single lever set and CARBON filter

BD.SACF0N04.CH

.CH  
cromo  
chrome



# cocinas | AQUA PURE

## monomando fregadero purificador caño alto

single lever high spout sink mixer with purifying function

- cartucho cerámico 35 mm  
35 mm ceramic cartridge
- caño giratorio  
swivel spout
- conexiones flexibles 3/8" 360 mm certificadas  
certified flexible 3/8" inlet pipes 360 mm
- función purificadora de agua  
water purifying function
- montura cerámica para función purificadora  
ceramic headpart for purifying function



BD.5195381.IX  
BD.5195381.BK

## OSMO NOX



Aireador antical  
Anti-scale aerator



Purificador  
Purifier



Sweet move®  
Sweet move®



Montura cerámica  
Ceramic head



Acero inoxidable  
Stainless steel



Sistema Easy Fit®  
Easy Fit® system



**pack AQUA PURE NOX**  
conjunto monomando cromado y sistema AQUA PURE  
chrome single lever set and AQUA PURE system

BD.PAPURE05.IX  
BD.PAPURE05.BK

BD.SACFON05.IX  
BD.SACFON05.BK

.IX  
inox  
inox

.BK  
negro  
black

## sistema de filtración completo AQUA PURE

AQUA PURE filtration complete system

- filtración partículas hasta 0,5 micras  
particles filtration 0,5 microns
- índice IODINE 1300  
IODINE index 1300
- capacidad: 26.000 litros\*  
filtration capacity: 26.000 litres\*
- caudal máximo: 4 LPM  
max. flow rate: 4 LPM
- presión de trabajo 1 - 8 bar  
work pressure: 1 - 8 bar
- temp. de trabajo 4°C - 38°C  
work temperature: 4°C - 38°C

\*según la calidad del agua de entrada  
y las condiciones de funcionamiento.  
according to the quality of the incoming water  
and the operating condition.

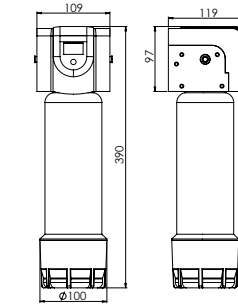

BD.AQUAPURE.PL



## recambio cartucho AQUA PURE

AQUA PURE spare part aqua pure cartridge

- filtración partículas hasta 0,5 micras  
particles filtration 0,5 microns
- índice IODINE 1300  
IODINE index 1300
- capacidad: 26.000 litros\*  
filtration capacity: 26.000 litres\*
- caudal máximo: 4 LPM  
max. flow rate: 4 LPM
- presión de trabajo 1 - 8 bar  
work pressure: 1 - 8 bar
- temp. de trabajo 4°C - 38°C  
work temperature: 4°C - 38°C

\*según la calidad del agua de entrada  
y las condiciones de funcionamiento.  
according to the quality of the incoming water  
and the operating condition.

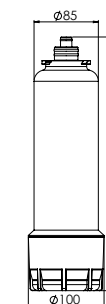

R.FILTROPURE.PL



## sistema de filtración SACRI FONTI

ACTIVE CARBON filtration system

- retención de sustancias y partículas generadoras de sabores y olores  
retention of substances and particles that generate flavors and odors
- retención/reducción del cloro libre presente en el agua  
retention/reduction of free chlorine present in the water
- reducción de la cantidad de compuestos orgánicos, trihalometanos y DQO  
Reduction of the quantity of organic compounds, trihalomethanes, and COD
- carbón activado granulado de cáscara de coco. 20 x 40 Mesh. lavado al ácido  
granulated activated carbon from coconut shell. 20 x 40 Mesh. Acid washed
- NSF. Vida útil: 1 año / 8300 l (en función de las características del agua)  
NSF. Lifespan: 1 year / 8300 liters (depending on water characteristics)
- caudal máximo: 1,9 LPM / 0,5 GPM  
maximum flow rate: 1.9 LPM / 0.5 GPM

\*según la calidad del agua de entrada  
y las condiciones de funcionamiento.  
according to the quality of the incoming water  
and the operating condition.

filtro + kit de instalación filter + instalation kit  
BD.SACRIFON.CH

recambio filtro filter replacement  
R.SACRIFON.CH

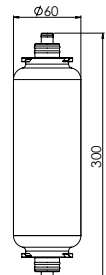



# cocinas CLASSIC



grifería de cocina clásica con un  
**giro moderno**

*classic kitchens with a modern twist*





## PORTIC

**monomando  
fregadero caño alto***single-lever high spout kitchen sink mixer*

- cartucho cerámico 35 mm  
*35 mm ceramic cartridge*
- caño giratorio  
*swivel spout*
- conexiones flexibles 3/8" 360 mm certificadas  
*certified flexible 3/8" inlet pipes 360 mm*

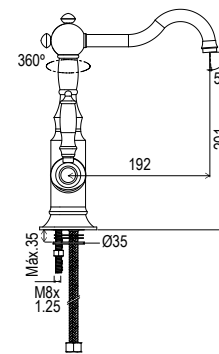
**Aireador antical**  
*Anti-scale aerator***Montura cerámica**  
*Ceramic head***Ecológico**  
*Ecological***Ahorra un 70% de agua**  
*Save 70% of water*

■ BD.5195201.CH  
■ BD.5195201.BR

**.CH**  
cromo  
*chrome***.BR**  
bronce  
*bronze*





## ST REMY

**monobloc  
fregadero***dual lever kitchen sink mixer*

- monturas cerámicas 1/4 vuelta  
*1/4 turn ceramic headparts*
- caño giratorio  
*swivel spout*
- conexiones flexibles 3/8" 360 mm certificadas  
*certified flexible 3/8" inlet pipes 360 mm*



**Aireador antical**  
*Anti-scale aerator*



**Montura cerámica**  
*Ceramic head*



**Ecológico**  
*Ecological*



**Ahorra un 70% de agua**  
*Save 70% of water*

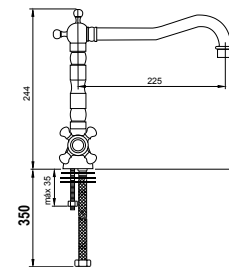

■ BD.5195301.CH

■ BD.5195301.BR

**.CH**  
cromo  
chrome

**.BR**  
bronce  
bronze



## CLASSIC

**monobloc  
fregadero***dual lever kitchen sink mixer*

- monturas cerámicas 1/4 vuelta  
*1/4 turn ceramic headparts*
- caño giratorio  
*swivel spout*
- conexiones flexibles 3/8" 360 mm certificadas  
*certified flexible 3/8" inlet pipes 360 mm*

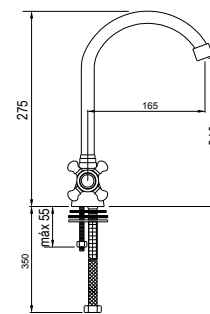
**Aireador antical**  
*Anti-scale aerator***Montura cerámica**  
*Ceramic head***Ecológico**  
*Ecological***Ahorra un 70% de agua**  
*Save 70% of water*

■ BD.5195291.CH  
■ BD.5195291.BR

**.CH**  
cromo  
*chrome***.BR**  
bronce  
*bronze*



# cocinas | ESSENTIAL

**propósito de  
austeridad**  
*purpose of austerity*





**mezclador monomando  
fregadero**  
*single lever kitchen sink mixer*

- cartucho de discos cerámicos 40 mm  
*40 mm ceramic cartridge*
- caño giratorio  
*swivel spout*
- conexiones flexibles 3/8" 360 mm certificadas  
*certified flexible 3/8" inlet pipes 360 mm*



Sweet move®  
Sweet move®



Aireador antical  
Anti-scale aerator



Ecológico  
Ecological



Ahorra un 70% de agua  
Save 70% of water

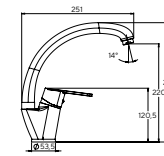
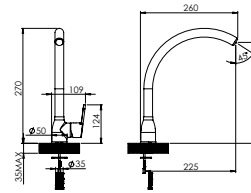

**NEW FORMA**

BD.5195N141.CH



**NEW FORMAS**

BD.5195131.CH

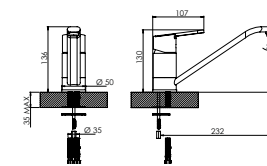
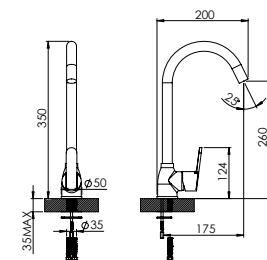

**NEW PURE**

BD.5195N111.CH



**NEW SCENIC**

BD.5193N111.CH





**mezclador monomando mural fregadero**  
single lever wall-mounted kitchen sink mixer

- cartucho de discos cerámicos 40 mm  
40 mm ceramic cartridge
- caño giratorio  
swivel spout



Sweet move®  
Sweet move®



Aireador antical  
Anti-scale aerator



Ecológico  
Ecological



Ahorra un 70% de agua  
Save 70% of water

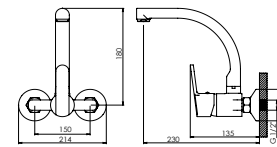

**NEW ALTUB S**

BD.5194141.CH

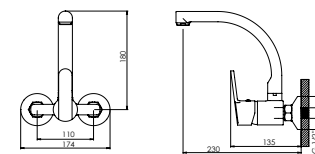

**NEW ADAPTIX**

BD.5194N131.CH

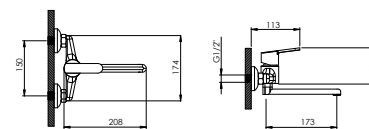

**NEW BATUB S**

BD.5192121.CH





**mezclador monomando  
fregadero extraíble 2 funciones**  
*single lever pull out kitchen sink mixer*

- cartucho de discos cerámicos 40 mm  
*40 mm ceramic cartridge*
- caño giratorio  
*swivel spout*
- ducha extraíble 2 funciones  
*2 function pull out shower*
- conexiones flexibles 3/8" 360 mm certificadas  
*certified flexible 3/8" inlet pipes 360 mm*



**Sweet move®**  
*Sweet move®*



**Aireador antical**  
*Anti-scale aerator*



**Extra resistente**  
*Extra resistant*



**Extraíble**  
*Pull Down*



**Ecológico**  
*Ecological*



**Ahorra un 70% de agua**  
*Save 70% of water*



**NEW EXBAX**

BD.5198N011.CH

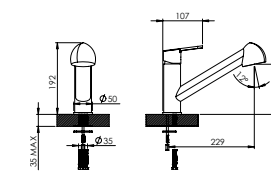

**NEW EXALT**

BD.5196N011.CH

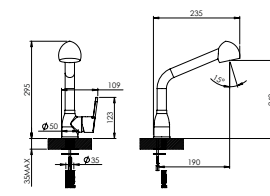



**buades** | la grifería

**sede central** *headquarter*

Velázquez, 27. 28001 Madrid, España

**logística** *logistics*

Juan de la Cierva, 18. 08960 Sant Just Desvern. Barcelona, España

Tel. + 34 93 595 08 32 [hola@buades-faucet.com](mailto:hola@buades-faucet.com)

**[buadesgriferia.com](http://buadesgriferia.com)**

**[buades-faucet.com](http://buades-faucet.com)**